

# Zappatrici

Rotary tillers  
Fraises rotatives  
Bodenfräsen  
Rotocultivadores



# La Gamma

Disponibili per trattori da 15 a 250 cv  
Available for tractors from 15 up to 250 hp  
Disponibles pour tracteurs de 15 à 250 cv  
Verfügbar für Traktoren von 15 bis 250 PS  
Disponibles para tractores de 15 a 250 hp

GB The range F La gamme D Die Auswahl E La gama

## Zappatrici rotative spostabili

GB SIDE SHIFT ROTARY TILLERS F FRAISES ROTATIVES DÉPORTABLES D BODENFRÄSEN MIT SEITLICHER VERSCHIEBUNG E ROTOCULTIVADORES CON DESPLAZAMIENTO



## Zappatrici rotative idrauliche

GB SIDE SHIFT ROTARY TILLERS F FRAISES ROTATIVES DÉPORTABLES D BODENFRÄSEN MIT SEITLICHER VERSCHIEBUNG E ROTOCULTIVADORES CON DESPLAZAMIENTO



## Zappatrici rotative fisse

GB ROTARY TILLERS F FRAISES ROTATIVES D BODENFRÄSEN E ROTOCULTIVADORES



# La Gamma

Disponibili per trattori da 15 a 250 cv

GB Available for tractors from 15 up to 250 hp

F Disponibles pour tracteurs de 15 à 250 cv

D Verfügbar für Traktoren von 15 bis 250 PS

E Disponibles para tractores de 15 a 250 hp

GB The range F La gamme D Die Auswahl E La gama



B 60 PL  
(30-70 HP) cm 130-155-185-205



B 83  
(50-90 HP) cm 155-180-205-230



B 170V  
(70-170 HP) cm 250-280-300



B 250V  
(100-200 HP) cm 250-300



B 103  
(50-100 HP) cm 155-185-205-230-250



B 123  
(60-120 HP) cm 205-230-250-280-300

## Zappatrice rotativa pieghevole

GB FOLDING ROTARY TILLER F FRAISE ROTATIVE REPLIABLE D BODENFRÄSEN KLAPPBAR E ROTOCULTIVADORE PLEGABLE



DOBLE  
(150 - 250 HP) Cm. 360 - 400 - 460 - 500

TRASMISSIONE LATERALE

GB SIDE TRANSMISSION F TRANSMISSION LATÉRALE D SEITLICHES GETRIEBE E TRASMISSION LATERAL

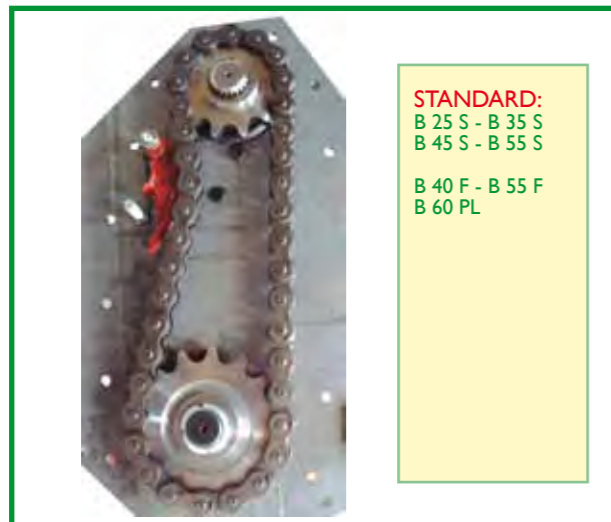

**STANDARD:**  
B 25 S - B 35 S  
B 45 S - B 55 S  
  
B 40 F - B 55 F  
B 60 PL

Catena con tedi catena  
GB Cain with automatic tensioner  
F Chaîne avec tendeur  
D Ketten mit automatischer stellenschraube  
E Cadena con tensore automatico

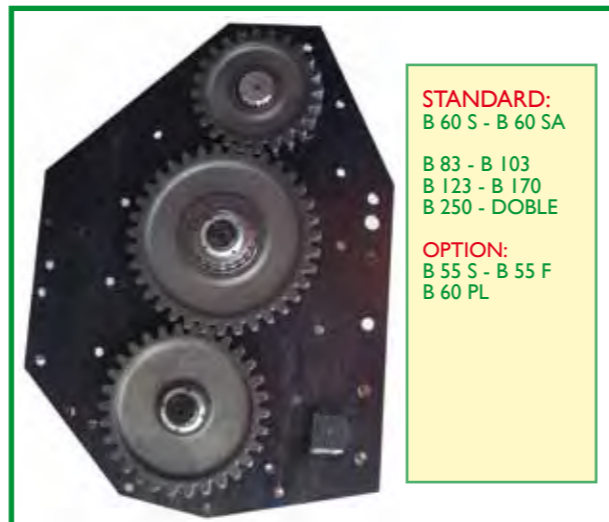

**STANDARD:**  
B 60 S - B 60 SA

B 83 - B 103  
B 123 - B 170  
B 250 - DOBLE

**OPTION:**  
B 55 S - B 55 F  
B 60 PL

Ingranaggi  
GB Gears  
F Pignons  
D Zahnradantrieb  
E Piñones

CAMBIO VELOCITÀ

GB GEARBOX F BOÎTIER D GETRIEBE E CAJA ENGRANAJES

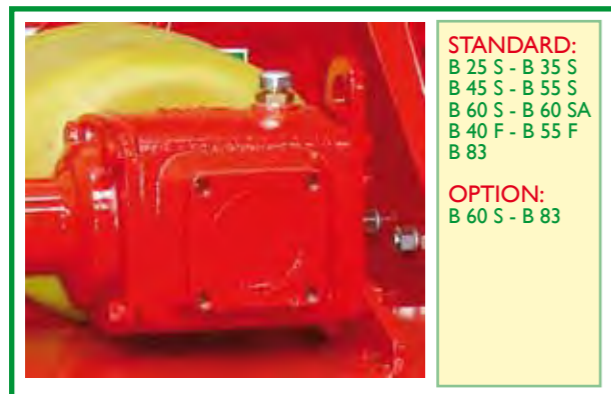

**STANDARD:**  
B 25 S - B 35 S  
B 45 S - B 55 S  
B 60 S - B 60 SA  
B 40 F - B 55 F  
B 83

**OPTION:**  
B 60 S - B 83

Scatola cambio I velocità  
GB Single speed gearbox  
F Boîtier monovitesse  
D Einganggetriebe  
E Caja engr. I velocidad

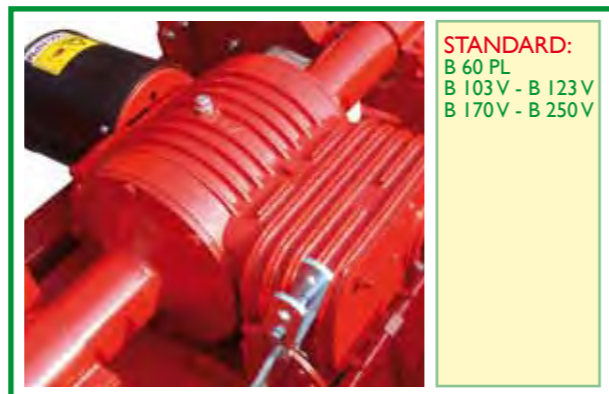

**STANDARD:**  
B 60 PL  
B 103V - B 123V  
B 170V - B 250V

Scatola cambio multi velocità  
GB Multi speed gearbox  
F Boîtier de vitesses  
D Wechselrad getriebe  
E Caja de velocidades



Doble: scatola cambio I velocità  
GB Single speed gearbox  
F Boîtier monovitesse  
D Einganggetriebe  
E Caja engr. I velocidad



REGOLAZIONE PROFONDITÀ DI LAVORO

GB WORKING DEPTH ADJUSTMENT F RÉGLAGE PROFONDEUR DE TRAVAIL D ARBEITSTIEFE E REGULACIÓN PROFUNDIDAD DE TRABAJO

SLITTE

GB Skids F Patins D Kufen E Patines



**STANDARD:**  
B 25 S - B 35 S  
B 45 S - B 55 S  
B 40 F - B 55 F  
B 60 PL - B 83  
B 103 - B 123  
B 170V - B 125V



**STANDARD:**  
B 60 S - B 60 SA



**STANDARD:**  
DOBLE

Con catena  
GB With chain  
F Avec chaîne  
D Mitt kette  
E Con cadena

RULLI POSTERIORI

GB Rollers F Rouleaux D Walzen E Rodillos



**OPTION:**  
B 60 PL Ø 477  
B 83 Ø 477  
B 103 Ø 477  
B 123 Ø 477  
B 170V Ø 525  
B 250V Ø 526



**OPTION:**  
B 60 PL Ø 405  
B 83 Ø 405  
B 103 Ø 405  
B 123 Ø 405  
B 170V Ø 450  
B 250V Ø 450  
DOBLE Ø 450



**OPTION:**  
B 103 Ø 406  
B 123 Ø 464  
B 170V Ø 464  
B 250V Ø 500  
DOBLE Ø 464

COFANI POSTERIORI

GB REAR HOOD F CAPOT ARRIÈRE RÉGABLE D HAUBE E CAPÓ TRASERO



**STANDARD:**  
B 25 S  
B 35 S  
B 45 S  
B 55 S  
B 40 F  
B 55 F  
B 103  
B 123



**STANDARD:**  
B 60 PL  
B 83  
B 170V  
B 250V  
DOBLE

Con molle  
GB With springs  
F Avec ressorts  
D Mitt feder  
E Con resortes

SPOSTAMENTO LATERALE MECCANICO O IDRAULICO

GB MECHANICAL OR HYDRAULIC SIDE SHIFT F DÉPORT LATÉRAL MÉCANIQUE OU HYDRAULIQUE  
D MECANISCHE ODER HYDRAULISCHE SEITENVERSCHIEBUNG E DESPLAZAMIENTO LATERAL MECANICO O HIDRAULICO



STANDARD:  
B 25 S / B 35 S / B 45 S / B 55 S



STANDARD: HYDRAULIC  
B 60 S



STANDARD: HYDRAULIC and AUTOMATIC  
B 60 SA

ATTACCHI POSTERIORI SPOSTABILI

GB SIDE SHIFT LOWER LINKAGES F ATTELAGES INFÉRIEURS DÉPORTABLES  
D NIEDRIGE ANBAUBOCKE E ENGANCHES INFERIORES DESPLAZABLES



STANDARD:  
B 40 F / B 55 F / B 60 PL / B 83

ATTACCHI ANTERIORI OSCILLANTI

GB FRONT FLOATING HITCHES F ATTELAGES OSCILLANTS  
D BEWEGLICHE TRAKTORANSCHLÜSSE E ENGANCHES DELANTEROS OSCILANTES



STANDARD:  
B 103 / B 123 / B 170V / B 250V / DOBLE

ROTORI

GB ROTORS F ROTORS D ROTOREN E ROTORES



Disponibile per: GB Available on: F Disponible pour: D Vorhanden an: E Disponible por:

- 1 Tutta la gamma con zappette a virgola o squadra GB All the range with "C" or "L" blades F Toute la gamme avec lames coudées ou à equerre D Der ganze bereich mit bogenmesser oder winkelmesser E Toda la gamma con cuchillas a "C" o "L"
- 2 Mod. BK per: For - Pour - Für - Por B 170V - DOBLE
- 3 Mod. SPIKE per: For - Pour - Für - Por B 123 - B 170V - DOBLE
- 4 Mod. FLASH per: For - Pour - Für - Por B 83 - B 103 - B 123 - B 170V



OPTION:  
Ø cm: 280 B 25 S - B 35 S  
Ø cm: 280 B 45 S - B 55 S  
Ø cm: 280 B 40 F - B 55 F  
Ø cm: 280 B 60 PL - B 60 S  
Ø cm: 280 B 60 SA - B 83



OPTION:  
Ø cm: 320 B 103 - B 123  
Ø cm: 320 B 170V - B 250V

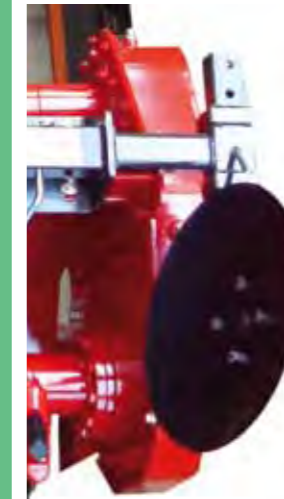

OPTION:  
B 103 - B 123 - B 170V  
B 250V - DOBLE

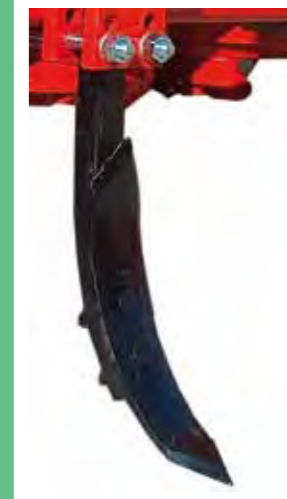

OPTION:  
B 103 - B 123 - B 170V  
B 250V - DOBLE

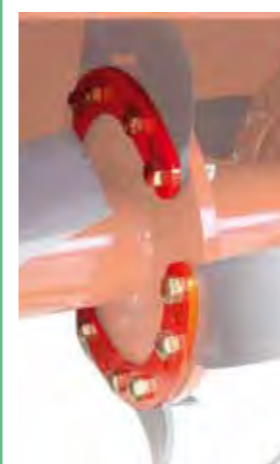

OPTION:  
B 60 PL - B 60 S - B 60 SA  
B 83 - B 103 - B 123  
B 170V - B 250V  
STANDARD: DOBLE



OPTION:  
B 123 - B 170V - B 250V



OPTION:  
B 123 - B 170V - B 250V  
STANDARD: DOBLE

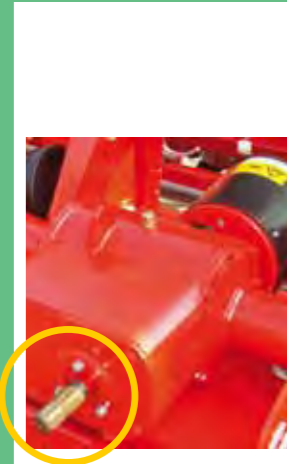

OPTION:  
B 123  
STANDARD: B 170 - B 250V

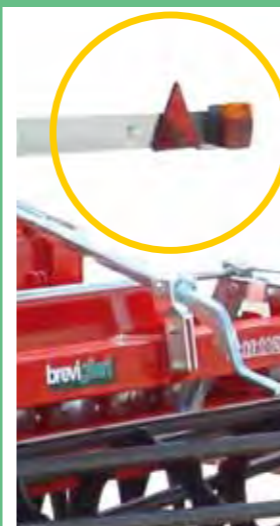

STANDARD: DOBLE



OPTION:  
B 25 S - B 35 S - B 45 S  
STANDARD: B 55 S - B 55 F  
B 60 PL - B 60 S  
B 60 SA - B 83  
B 103



OPTION:  
B 45 S - B 55 S - B 40 F  
B 55 F - B 60 PL - B 60 S  
B 60 SA - B 83 - B 103  
STANDARD: B 123  
B 170V  
B 250V



OPTION:  
B 60 PL - B 60 S - B 60 SA  
B 83 - B 103 - B 123  
B 170V - B 250V  
STANDARD: DOBLE

MOD.								
	RPM	RPM	HP	Kg.			N.	Cm.
B40F 85	540	230	15-20	130			16	5-15
B40F 105	540	230	15-25	160			20	5-15
B40F 125	540	230	20-30	190			24	5-15
B40F 145	540	230	25-35	220			28	5-15
B40F 155	540	230	30-40	230			32	5-15
B55F 125	540	230	25-35	245			36	5-15
B55F 145	540	230	30-45	265			42	5-15
B55F 165	540	230	35-50	290			48	5-15
B55F 185	540	230	35-60	322			54	5-15
X								
B60PL 130	540	188 210 263 294	30-45	320	450	440	30	5-15
B60PL 155	540	188 210 263 294	35-50	355	480	470	36	5-15
B60PL 185	540	188 210 263 294	45-60	400	510	500	42	5-15
B60PL 205	540	188 210 263 294	55-70	435	540	530	48	5-15
X								
B83 155	540	242	50-60	440	580	560	42	10-20
B83 180	540	242	50-70	470	620	600	48	10-20
B83 205	540	242	60-80	510	660	640	54	10-20
B83 230	540	242	70-90	550	700	680	60	10-20
X								
B103 155	540	169 238 301	50-70	620	710	790	36	10-25
B103 185	540	169 238 301	50-70	620	710	790	42	10-25
B103 205	540	169 238 301	60-75	650	750	820	48	10-25
B103 230	540	169 238 301	70-80	680	790	890	54	10-25
B103 250	540	169 238 301	75-100	710	840	920	60	10-25
B123 205	540 1000	214 240 302 293 374	60-70	750			48	10-25
B123 230	540 1000	214 240 302 293 374	60-90	800	970	1000	54	10-25
B123 255	540 1000	214 240 302 293 374	70-100	850	1020	1050	60	10-25
B123 280	540 1000	214 240 302 293 374	80-110	900	1070	1100	66	10-25
B123 300	540 1000	214 240 302 293 374	90-120	950	1120	1150	72	10-25
B170V 250	1000	244 303 338	70-120	940	1080	1080	60	10-20
B170V 280	1000	244 303 338	90-140	1020	1160	1160	66	10-20
B170V 300	1000	244 303 338	100-170	1100	1240	1240	72	10-20
B250V 250	1000	207 230 286	100-140	1160	1200	1240	60	10-20
B250V 300	1000	207 230 286	170-200	1320	1360	1400	72	10-20

X: con cofano with hood avec capot mit haube con tapa

MOD.								
	RPM	RPM	HP	Kg.			N.	Cm.
B25S 85	540	184	10-20	145			16	5-15
B25S 105	540	184	15-25	160			20	5-15
B25S 125	540	184	20-30	175			24	5-15
B35S 105	540	231	15-25	160			20	5-15
B35S 125	540	231	20-30	175			24	5-15
B35S 145	540	231	25-35	190			28	5-15
B45S 125	540	226	20-30	225			24	5-15
B45S 145	540	226	30-40	235			28	5-15
B45S 165	540	226	30-50	245			32	5-15
B55S 145	540	273	25-35	275			28	5-15
B55S 165	540	273	30-50	295			32	5-15
B55S 185	540	273	35-60	315			36	5-15

Vi: vigneto vineyard vignes weinbau viña  
Fr: frutteto orchard verger obstbau huerto  
Fr.L: frutteto larga grand verger obstbau breit huerto ancha

MOD.								
	RPM	RPM	HP	Kg.			N.	Cm.
B60S 130	540	210	25-45	Vi. 410	Fr. 405	Fr.L. -	30	5-15
B60S 155	540	210	35-50	440	435	430	36	5-15
B60S 185	540	210	45-60	470	465	460	42	5-15
B60S 205	540	210	55-70	500	495	490	48	5-15
X								
B60SA 130	540	210	25-45	Vi. 430	Fr. 420	Fr.L. -	30	5-15
B60SA 155	540	210	35-60	460	455	460	36	5-15
B60SA 185	540	210	40-70	500	500	500	42	5-15
B60SA 205	540	210	55-70	540	540	540	48	5-15

MOD.								
	RPM	RPM	HP	Kg.			N.	Cm.
X								
DOBLE 360	1000	258	150-200	2040	2390	2620	84	10-20
DOBLE 400	1000	258	180-220	2155	2500	2740	96	10-20
DOBLE 460	1000	258	200-230	2310	2655	2895	108	10-20
DOBLE 500	1000	258	220-250	2400	2760	3055	120	10-20

X: con cofano with hood avec capot mit haube con tapa

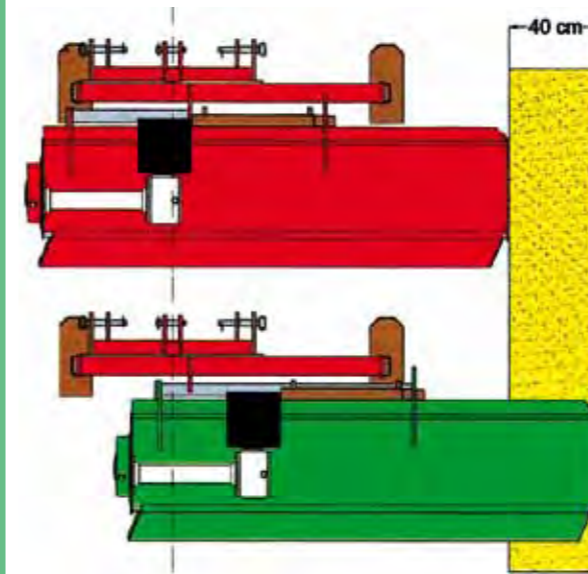

b60s/sa 130	Vi.		67
b60s/sa 130	Fr.		107
b60s/sa 155	Vi.		82
b60s/sa 155	Fr.		122
b60s/sa 155	Fr. L		102
b60s/sa 155	Fr. L		142
b60s/sa 155	Fr. L		152
b60s/sa 155	Vi.		92
b60s/sa 155	Fr.		132
b60s/sa 155	Fr.		122
b60s/sa 155	Fr. L		162
b60s/sa 155	Fr. L		142
b60s/sa 155	Fr. L		182
b60s/sa 155	Vi.		102
b60s/sa 155	Fr.		142
b60s/sa 155	Fr.		132
b60s/sa 155	Fr. L		172
b60s/sa 155	Fr. L		152
b60s/sa 155	Fr. L		192

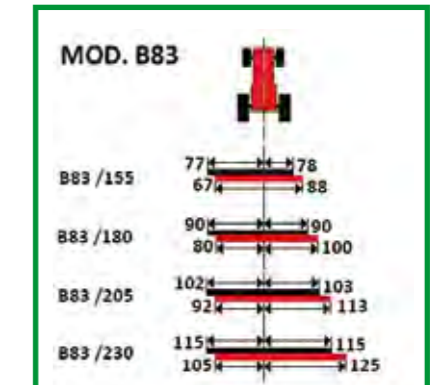
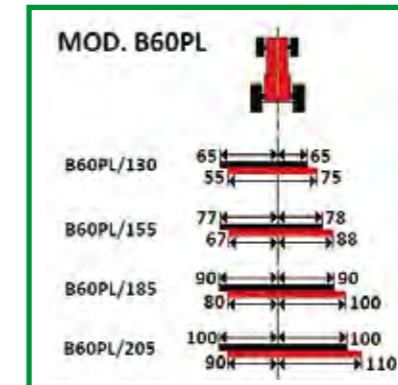
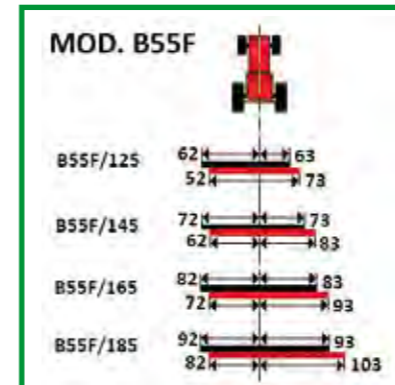
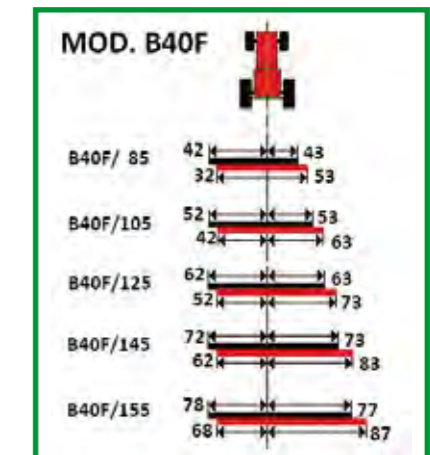
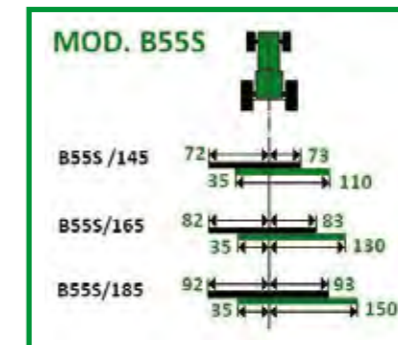
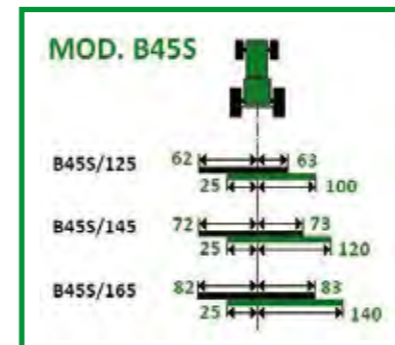
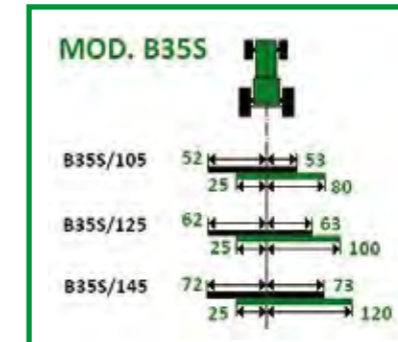
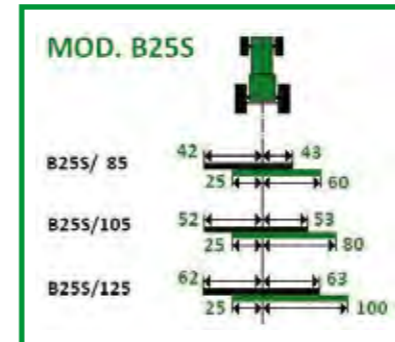



breviglieri

Via Labriola 2 - 37054 NOGARA (Verona) - ITALY - Tel. +39 0442 537411 r.a. - Fax +39 0442 537444 - Export: Tel. +39 0442 537402  
www.breviglieri.com - export@breviglieri.com - info@breviglieri.com